

# RIEGL LMS-Q780

- up to 266 000 measurements/sec on the ground
- operating flight altitude up to 15,500 ft AGL
- multiple time around processing: more than 10 pulses (MTA zone 10) simultaneously in the air
- full waveform analysis for unlimited number of target echoes
- high laser pulse repetition rate up to 400 kHz
- various laser power settings for different fields of application
- high ranging accuracy  $\leq 20$  mm
- high scan speed up to 200 lines/sec
- wide scan field of view of 60°
- parallel scan lines
- suited for measuring snowy and icy terrain
- interface for smooth and direct GNSS-time synchronization
- seamless integration and compatibility with other RIEGL ALS-systems and software packages

The new **RIEGL® LMS-Q780** long-range airborne laser scanner makes use of a powerful laser source, multiple-time-around (MTA) processing, echo digitization and waveform analysis. This combination allows the operation at varying flight altitudes and is therefore ideally suited for aerial survey of complex terrain.

The **RIEGL LMS-Q780** gives access to detailed target parameters by digitizing the echo signal online during data acquisition, and subsequent off-line waveform analysis. This method is especially valuable when dealing with difficult tasks, such as canopy height investigation or target classification. Multiple-time-around processing allows the utilization of target echo signals which have been detected out of the unambiguity range between two successive laser pulses. In post-processing the correct allocation of ambiguous echo ranges is accomplished by using **RiANALYZE** in combination with the associated plugin **RiMTA**.

The operational parameters of the **RIEGL LMS-Q780** can be configured to cover a wide field of applications. Comprehensive interface features support smooth integration of the instrument into a complete airborne scanning system.

The instrument makes use of the time-of-flight distance measurement principle of infrared nanosecond pulses. Fast opto-mechanical beam scanning provides absolutely linear, unidirectional and parallel scan lines. The instrument is extremely rugged, therefore ideally suited for the installation on aircraft. Also, it is compact and lightweight enough to be installed in small twin- or single-engine planes, helicopters or UAVs. The instrument needs only one power supply and GPS timing signals to provide online monitoring data while logging the precisely time-stamped and digitized echo signal data to the rugged **RIEGL** Data Recorder.

## Applications:

### Full Laser Power:

- Wide Area / High Altitude Mapping
- Topography & Mining
- Glacier & Snowfield Mapping

### Reduced Laser Power:

- City Modeling
- Mapping of Lakesides & River Banks
- Agriculture & Forestry
- Corridor Mapping

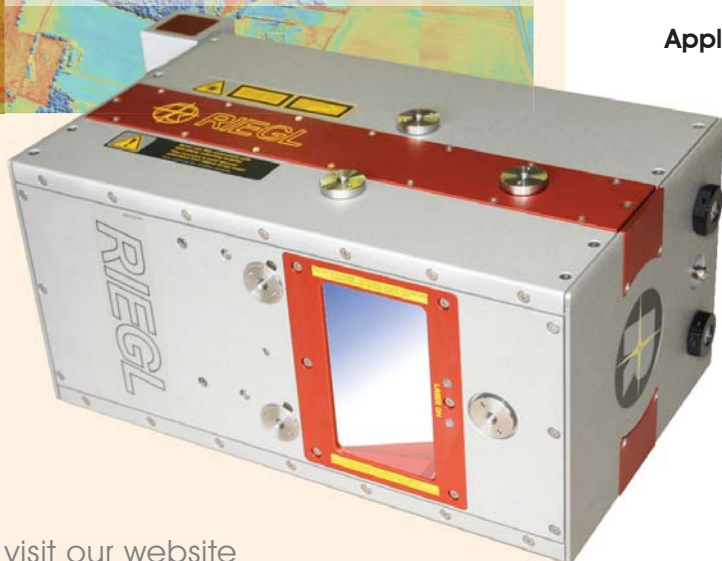

visit our website  
[www.riegl.com](http://www.riegl.com)



**RIEGL®**  
LASER MEASUREMENT SYSTEMS

# Technical Data RIEGL LMS-Q780

## Laser Product Classification

## Class 3B Laser Product according to IEC60825-1:2007

The following clause applies for instruments delivered into the United States: Complies with 21 CFR 1040.10 and 1040.11 except for deviations pursuant to Laser Notice No. 50, dated June 24, 2007.

The instrument must be used only in combination with the appropriate laser safety box.

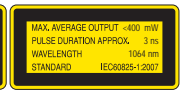

## Range Measurement Performance

### Full Laser Power

as a function of laser power setting, PRR, and target reflectivity

Laser Power Level	100%			
	100 kHz	200 kHz	300 kHz	400 kHz
Laser Pulse Repetition Rate (PRR)				
Max. Measuring Range <sup>1) 3)</sup>				
natural targets $\rho \geq 20\%$	4100 m	3500 m	3000 m	2700 m
natural targets $\rho \geq 60\%$	5800 m	5100 m	4500 m	4100 m
Max. Operating Flight Altitude Above Ground Level (AGL) <sup>2) 3)</sup>	4700 m 15500 ft	4200 m 13700 ft	3700 m 12000 ft	3300 m 11000 ft
NOHD <sup>4)</sup>	200 m	160 m	125 m	105 m
ENOHD <sup>5)</sup>	1500 m	1200 m	960 m	820 m

- 1) The following conditions are assumed: • target is larger than the footprint of the laser beam • average ambient brightness • visibility 40 km  
• perpendicular angle of incidence • ambiguity resolved by multiple-time-around processing
- 2) Reflectivity  $\rho \geq 60\%$ , max. scan angle  $60^\circ$ , additional roll angle  $\pm 5^\circ$
- 3) In bright sunlight the operational range may be considerably shorter and the operational flight altitude may be considerably lower than under an overcast sky.
- 4) Nominal Ocular Hazard Distance, based upon MPE according to IEC60825-1:2007, for single pulse condition
- 5) Extended Nominal Ocular Hazard Distance, based upon MPE according to IEC60825-1:2007, for single pulse condition

### Reduced Laser Power

Laser Power Level	50%	25%	12%	6%
Laser Pulse Repetition Rate (PRR)	400 kHz	400 kHz	400 kHz	400 kHz
Max. Measuring Range <sup>6) 8)</sup>				
natural targets $\rho \geq 20\%$	2100 m	1500 m	1120 m	820 m
natural targets $\rho \geq 60\%$	3200 m	2400 m	1800 m	1350 m
Max. Operating Flight Altitude Above Ground Level (AGL) <sup>7) 8)</sup>	2600 m 8600 ft	1950 m 6400 ft	1450 m 4800 ft	1100 m 3600 ft
NOHD <sup>9)</sup>	70 m	68 m	44 m	25 m
ENOHD <sup>10)</sup>	560 m	550 m	360 m	250 m

- 6) The following conditions are assumed: • target is larger than the footprint of the laser beam • average ambient brightness • visibility 40 km  
• perpendicular angle of incidence • ambiguity resolved by multiple-time-around processing
- 7) Reflectivity  $\rho \geq 60\%$ , max. scan angle  $60^\circ$ , additional roll angle  $\pm 5^\circ$
- 8) In bright sunlight the operational range may be considerably shorter and the operational flight altitude may be considerably lower than under an overcast sky.
- 9) Nominal Ocular Hazard Distance, based upon MPE according to IEC60825-1:2007, viewing a single scan line
- 10) Extended Nominal Ocular Hazard Distance, based upon MPE according to IEC60825-1:2007, viewing a single scan line

Minimum Range <sup>11)</sup>  
Accuracy <sup>12) 13)</sup>  
Precision <sup>12) 14)</sup>  
Laser Pulse Repetition Rate  
Effective Measurement Rate  
Laser Wavelength  
Laser Beam Divergence <sup>15)</sup>  
Number of Targets per Pulse

50 m  
20 mm  
20 mm  
up to 400 kHz  
up to 266 kHz @  $60^\circ$  scan angle  
near infrared  
 $\leq 0.25$  mrad  
digitized waveform processing: unlimited <sup>16)</sup>  
monitoring data output: first pulse

## Scanner Performance

Scanning Mechanism  
Scan Pattern  
Scan Angle Range  
Scan Speed  
  
Angular Step Width  $\Delta\theta$  <sup>19)</sup>  
  
Angle Measurement Resolution  
Scan Sync

rotating polygon mirror  
parallel scan lines  
 $\pm 30^\circ = 60^\circ$  total  
14 - 200 lines/sec<sup>17)</sup> @ laser power level  $\geq 50\%$   
10 - 200 lines/sec<sup>18)</sup> @ laser power level  $< 50\%$   
 $\Delta\theta \geq 0.012^\circ$  @ laser power level  $\geq 50\%$   
 $\Delta\theta \geq 0.006^\circ$  @ laser power level  $< 50\%$   
0.001°  
Option for synchronizing scan lines to external timing signal

## Intensity Measurement

For each echo signal, high-resolution 16-bit intensity information is provided which can be used for target discrimination and/or identification/classification.

11) Limitation for range measurement capability, does not consider laser safety!  
12) Standard deviation one sigma @ 250 m range under RIEGL test conditions.  
13) Accuracy is the degree of conformity of a measured quantity to its actual (true) value.  
14) Precision, also called reproducibility or repeatability, is the degree to which further measurements show the same result.

15) Measured at the  $1/e^2$  points. 0.25 mrad correspond to an increase of 25 cm of beam diameter per 1000 m distance.  
16) Practically limited only by the maximum data rate allowed for the RIEGL Data Recorder.  
17) Minimum scan speed increasing linearly to 53 lines/sec @ 400 000 Hz PRR @ laser power  $\geq 50\%$

18) Minimum scan speed increasing linearly to 27 lines/sec @ 400 000 Hz PRR @ laser power  $< 50\%$   
19) Angle between consecutive laser shots, user adjustable

## Echo Signals from Different Targets

The waveform digitization feature of the *RIEGL* LMS-Q780 enables the user to extract most comprehensive information from the echo signals.

Figure 1 illustrates a measurement situation where 3 laser measurements are taken on different types of targets. The red pulses symbolize the laser signals travelling towards the target with the speed of light. When the signal interacts with the diffusely reflecting target surface, a fraction of the transmitted signal is reflected towards the laser instrument, indicated by the blue signals.

In situation 1, the laser pulse hits the canopy first and causes three distinct echo pulses. A fraction of the laser pulse also hits the ground giving rise to another echo pulse. In situation 2, the laser beam is reflected from a flat surface at a small angle of incidence yielding an extended echo pulse width. In situation 3, the pulse is simply reflected by a flat surface at perpendicular incidence resulting in one single echo pulse with a shape identical to the transmitted laser pulse.

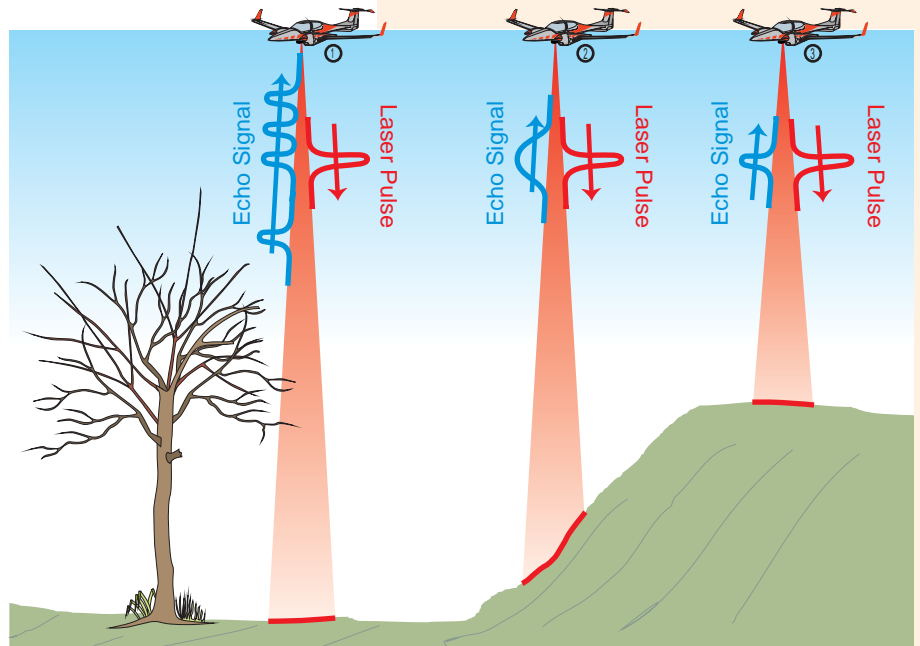

Fig. 1 Echo signals resulting from different types of targets

## Echo Digitization *RIEGL* LMS-Q780

The upper line of the acquisition diagram shows the analog signals: the first (red) pulse relates to a fraction of the laser transmitter pulse, and the next 3 (blue) pulses correspond to the reflections by the branches of the tree; the last pulse corresponds to the ground reflection.

This analog echo signal is sampled at constant time intervals (middle line) and is, in the following, analog-to-digital converted, resulting in a digital data stream (bottom line of the acquisition section). This data stream is stored in the *RIEGL* Data Recorder for subsequent off-line post processing, where the echo signals can be perfectly reconstructed and analyzed in detail to precisely derive target distance, pulse shape as an indicator for target type, and other parameters.

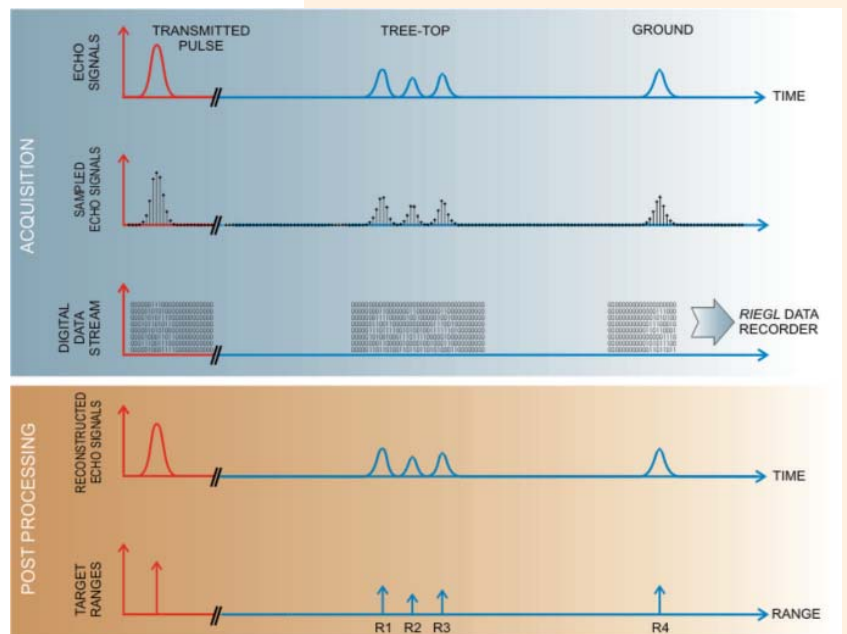

Fig. 2 Data acquisition and post processing

Based upon *RIEGL*'s long-standing expertise and experience in designing, manufacturing and marketing digitizing laser rangefinders for challenging industrial and surveying applications, and due to the careful design of the analog and digital front-end electronics, the LMS-Q780 records the complete information of the echo signal over a wide dynamic range. Thus, in post-processing the signal can be perfectly reconstructed and analyzed in detail to precisely derive target distance, target type, and other parameters.

# Multiple-Time-Around Data Acquisition and Processing

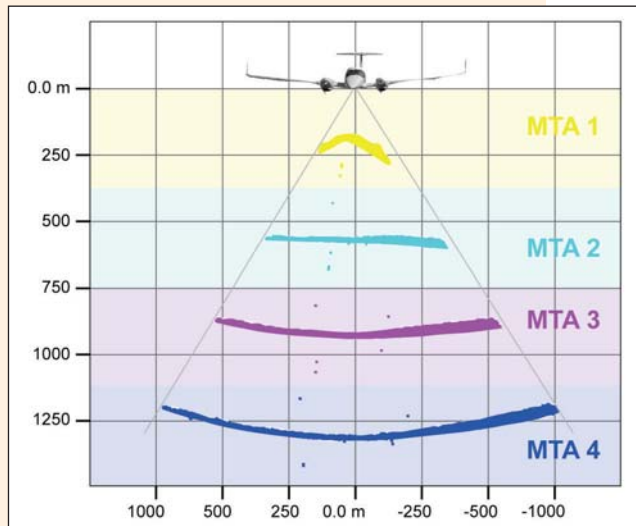

Fig. 3 Profile of scan data processed in MTA zones 1 to 4

In time-of-flight laser ranging a maximum unambiguous measurement range exists which is defined by the measurement repetition rate and the speed of light. When scanning at a pulse repetition rate of, e.g., 400 kHz, measurement ranges above approx. 375 m are ambiguous caused by an effect known as "Multiple-Time-Around" (MTA). In such case target echoes received may not be associated with their preceding laser pulses emitted any longer (MTA-zone 1), but have to be associated with their last but one (MTA-zone 2), or even last but two laser pulses emitted (MTA-zone 3), in order to determine the true measurement range.

Figure 3 gives an impression of ALS data where each single echo of a scan line is associated with each of its last four preceding laser shots emitted. Each single echo is represented by a measurement range calculated in MTA zone 1, 2, 3 and 4 respectively, but only one of the four realizations represents the true point cloud model of the scanned earth surface. The chosen example shows scan data correctly allocated in MTA zone 2, where the earth surface appears more or less flat in contrast to the typical spatial characteristics of incorrectly calculated ambiguous ranges in MTA zones 1, 3 and 4.

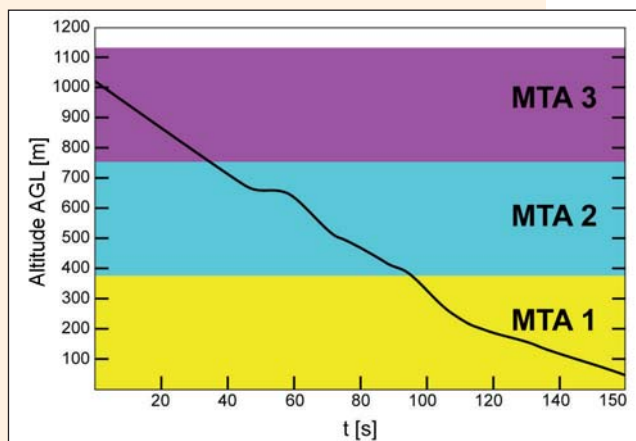
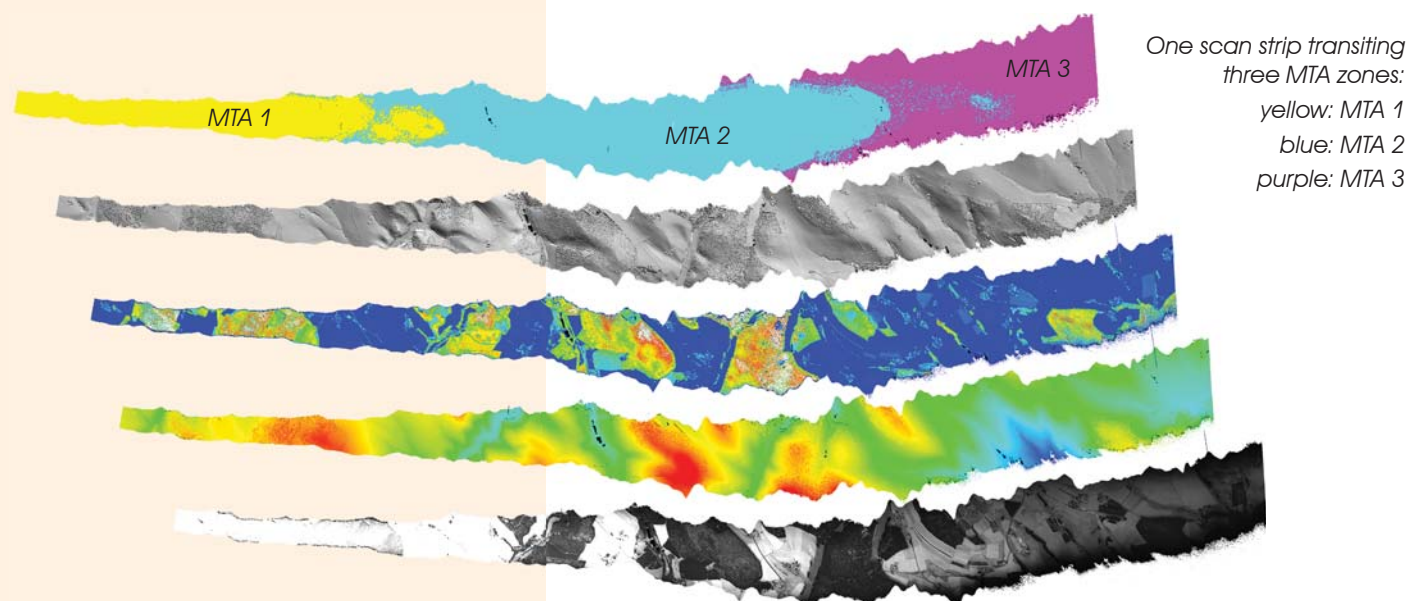

Fig. 4 Flight altitude above ground level descending from 1,000 m to 240 m within 150 seconds

The RIEGL LMS-Q780 is capable of acquiring echo signals which arrive after a delay of more than one pulse repetition interval, thus allowing range measurements beyond the maximum unambiguous measurement range. Unique techniques in high-speed signal processing and a novel modulation scheme applied to the train of emitted laser pulses permit range measurements without any perceivable gaps at any distance within the instrument's maximum measurement range. The specific modulation scheme applied to the train of emitted laser pulses avoids a total loss of data at the transitions between MTA-zones and retains range measurement at approximately half the point density.

The correct resolution of ambiguous echo ranges is accomplished using RiANALYZE in combination with the associated plugin RIMTA ALS, which does not require any further user interaction, and maintains fast processing speed for mass data production.



# Measurement Range & Point Density RIEGL LMS-Q780

PRR = 100 kHz, laser power level 100%

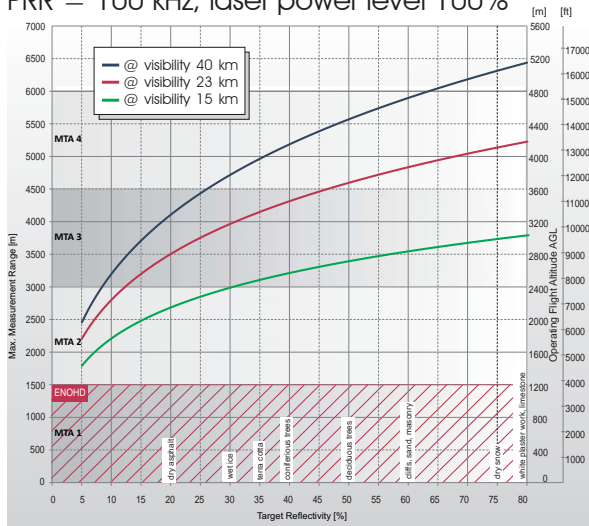

Example: LMS-Q780 at 100,000 pulses/sec, laser power level 100%  
Altitude = 6100ft AGL, Speed = 100 kn

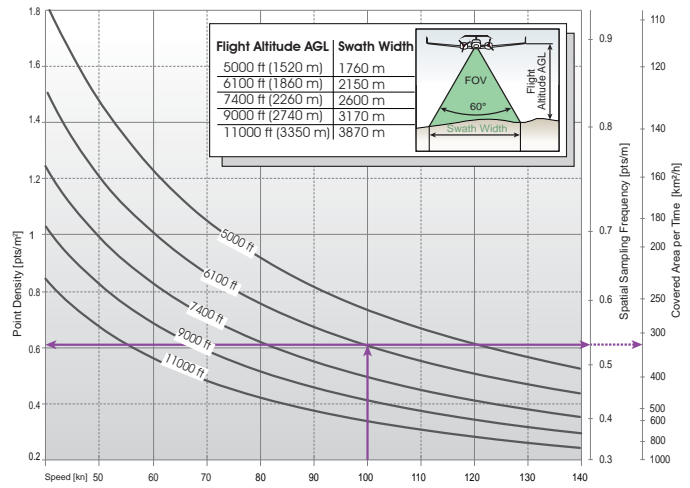

Results: Point Density ~ 0.6 pts/m<sup>2</sup>  
Spatial Sampling Frequency ~ 0.53 pts/m  
Covered Area per Time ~ 320 km<sup>2</sup>/h

PRR = 200 kHz, laser power level 100%

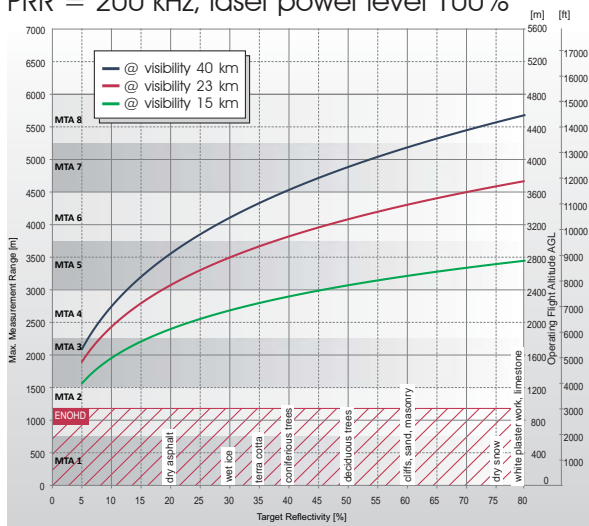

Example: LMS-Q780 at 200,000 pulses/sec, laser power level 100%  
Altitude = 5700ft AGL, Speed = 80 kn

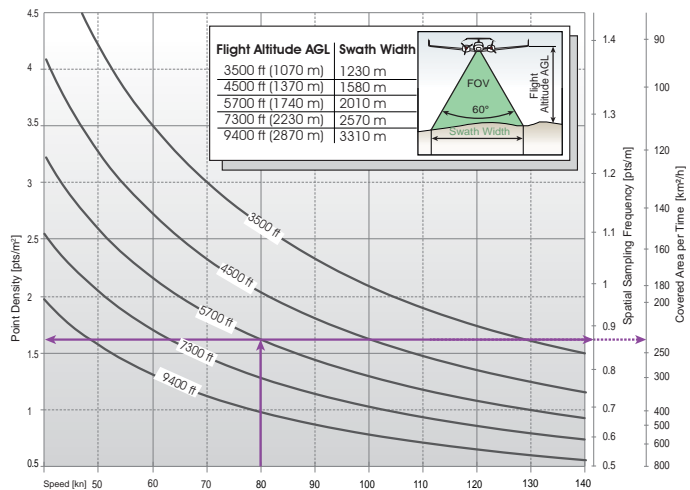

Results: Point Density ~ 1.6 pts/m<sup>2</sup>  
Spatial Sampling Frequency ~ 0.87 pts/m  
Covered Area per Time ~ 230 km<sup>2</sup>/h

PRR = 300 kHz, laser power level 100%

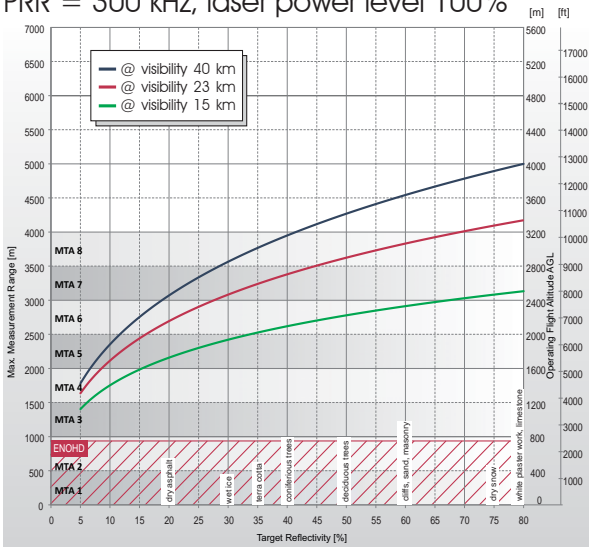

Example: LMS-Q780 at 300,000 pulses/sec, laser power level 100%  
Altitude = 4000ft AGL, Speed = 70 kn

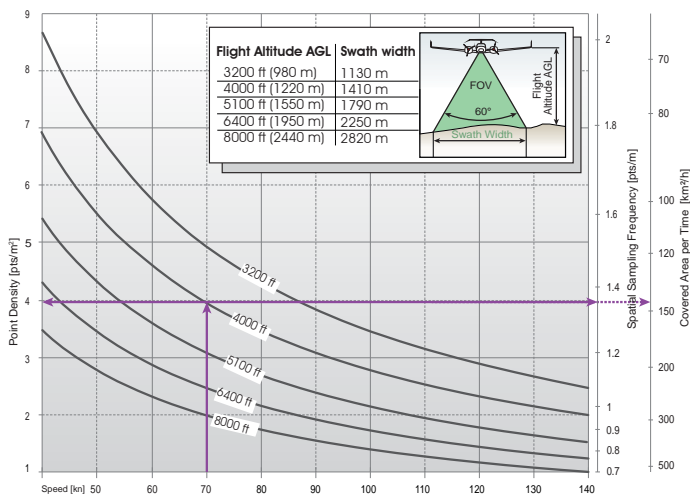

Results: Point Density ~ 4 pts/m<sup>2</sup>  
Spatial Sampling Frequency ~ 1.35 pts/m  
Covered Area per Time ~ 140 km<sup>2</sup>/h

**The following conditions are assumed for the Operating Flight Altitude AGL**

- ambiguity resolved by multiple-time-around (MTA) processing & flight planning
- target size  $\geq$  laser footprint
- scan angle 60°
- average ambient brightness
- roll angle  $\pm 5^\circ$

**Assumptions for calculation of the Covered Area per Time**

- 20% overlap of neighboring flight strips. This overlap covers a roll angle of  $\pm 5^\circ$  or a reduction of flight altitude AGL of 20%.

**Definition of the Spatial Sampling Frequency**

- The Spatial Sampling Frequency is the reciprocal of the 95th percentile of the distribution function of the maximum distances between neighboring scan points. When considering any individual scan point, the probability to find its most distant neighbor within the reciprocal of the Spatial Sampling Frequency is 95%.

# Measurement Range & Point Density RIEGL LMS-Q780

PRR = 400 kHz, laser power level 100%

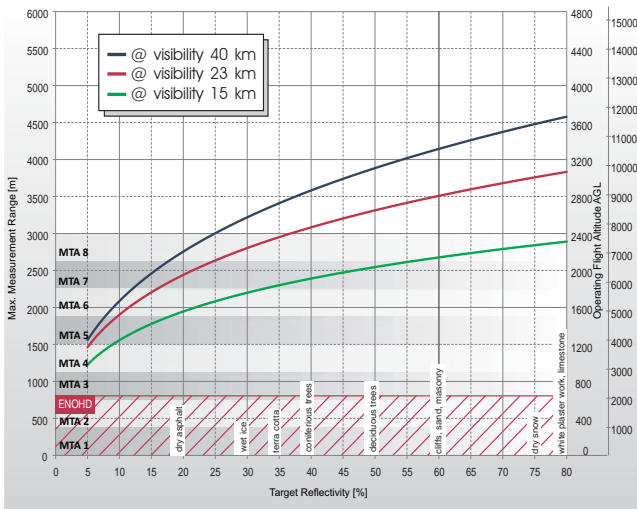

Example: LMS-Q780 at 400,000 pulses/sec, laser power level 100%  
Altitude = 2700ft AGL, Speed = 85 kn

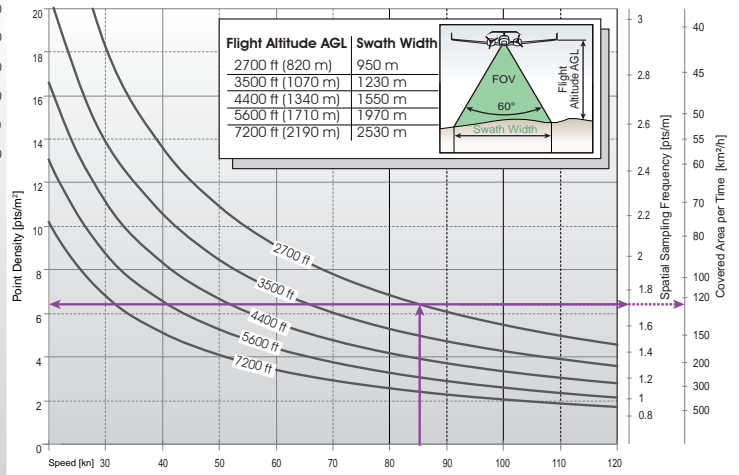

Results: Point Density ~ 6.4 pts/m<sup>2</sup>  
Spatial Sampling Frequency ~ 1.7 pts/m  
Covered Area per Time ~ 125 km<sup>2</sup>/h

PRR = 400 kHz, laser power level 50%

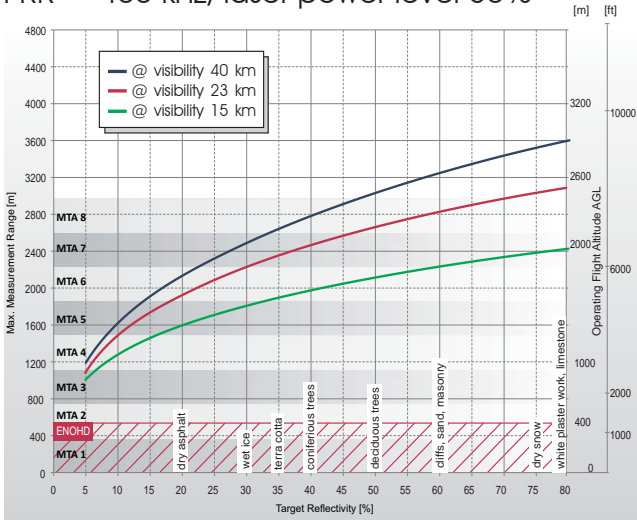

Example: LMS-Q780 at 400,000 pulses/sec, laser power level 50%  
Altitude = 2500ft AGL, Speed = 70 kn

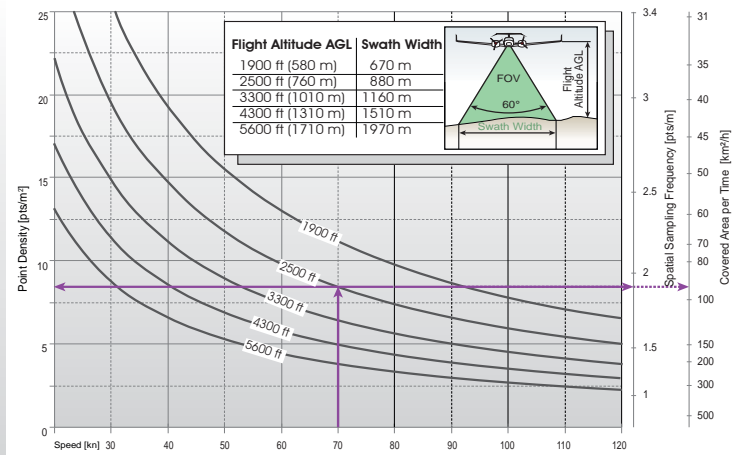

Results: Point Density ~ 8.4 pts/m<sup>2</sup>  
Spatial Sampling Frequency ~ 1.9 pts/m  
Covered Area per Time ~ 95 km<sup>2</sup>/h

PRR = 400 kHz, laser power level 25%

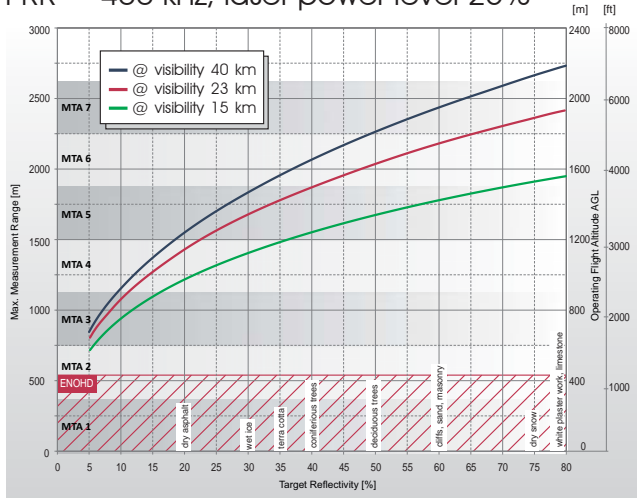

Example: LMS-Q780 at 400,000 pulses/sec, laser power level 25%  
Altitude = 2800ft AGL, Speed = 90 kn

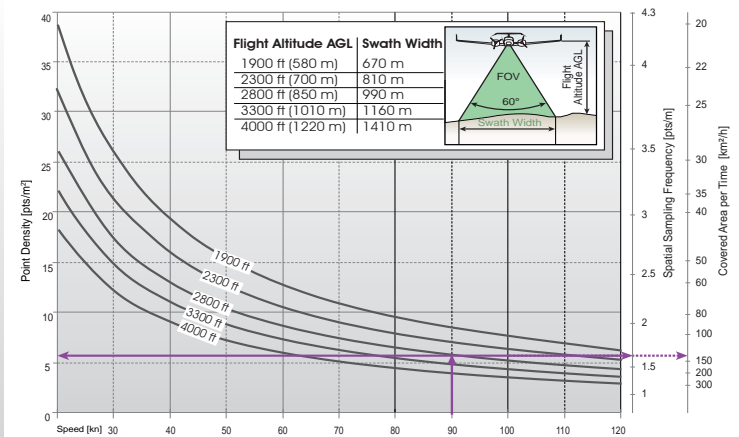

Results: Point Density ~ 5.8 pts/m<sup>2</sup>  
Spatial Sampling Frequency ~ 1.6 pts/m  
Covered Area per Time ~ 140 km<sup>2</sup>/h

**The following conditions are assumed for the Operating Flight Altitude AGL**

- ambiguity resolved by multiple-time-around (MTA) processing & flight planning
- target size ≥ laser footprint
- scan angle 60°
- average ambient brightness
- roll angle ±5°

**Assumptions for calculation of the Covered Area per Time**

- 20% overlap of neighboring flight strips. This overlap covers a roll angle of ±5° or a reduction of flight altitude AGL of 20%.

**Definition of the Spatial Sampling Frequency**

The Spatial Sampling Frequency is the reciprocal of the 95th percentile of the distribution function of the maximum distances between neighboring scan points. When considering any individual scan point, the probability to find its most distant neighbor within the reciprocal of the Spatial Sampling Frequency is 95%.

# Measurement Range & Point Density RIEGL LMS-Q780

PRR = 400 kHz, laser power level 12%

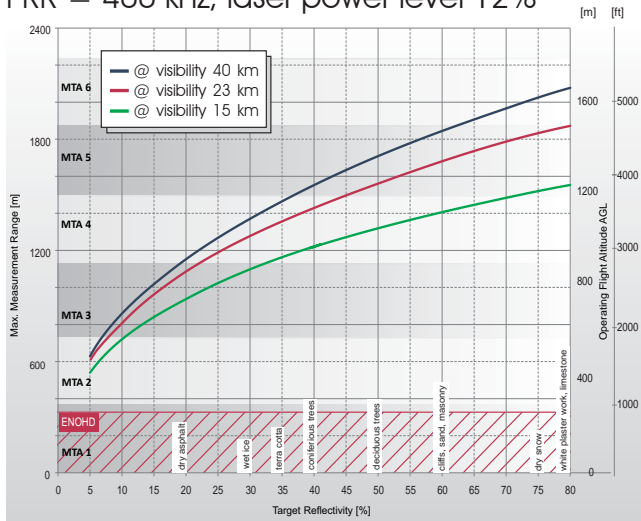

Example: LMS-Q780 at 400,000 pulses/sec, laser power level 12%  
Altitude = 1200ft AGL, Speed = 80 kn

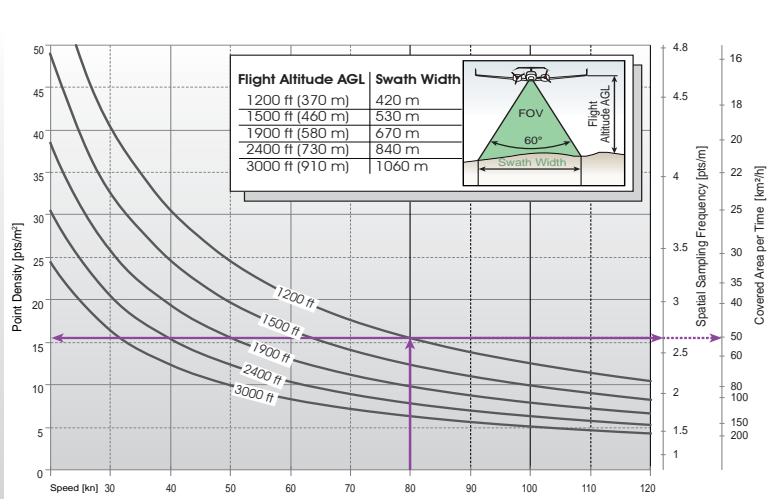

Results: Point Density ~ 15.3 pts/m<sup>2</sup>  
Spatial Sampling Frequency ~ 2.6 pts/m  
Covered Area per Time ~ 50 km<sup>2</sup>/h

PRR = 400 kHz, laser power level 6%

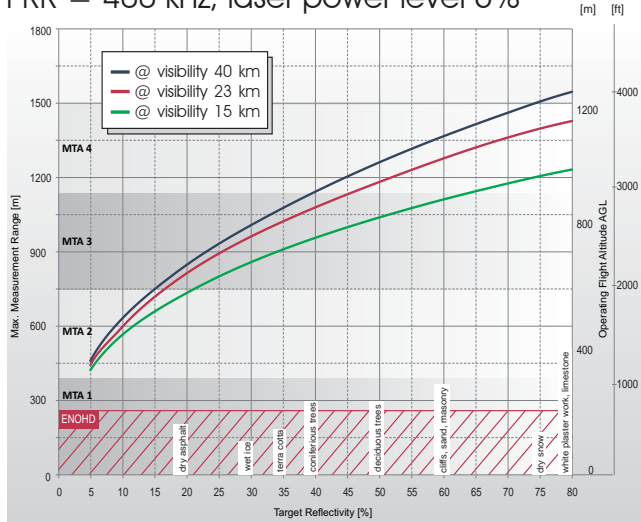

Example: LMS-Q780 at 400,000 pulses/sec, laser power level 6%  
Altitude = 850ft AGL, Speed = 70 kn

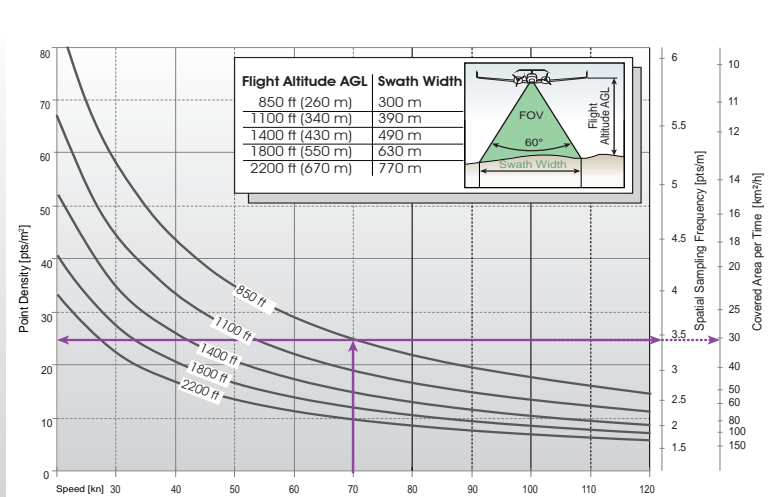

Results: Point Density ~ 24.7 pts/m<sup>2</sup>  
Spatial Sampling Frequency ~ 3.4 pts/m  
Covered Area per Time ~ 30 km<sup>2</sup>/h

### The following conditions are assumed for the Operating Flight Altitude AGL

- ambiguity resolved by multiple-time-around (MTA) processing & flight planning
- target size ≥ laser footprint
- scan angle 60°
- average ambient brightness
- roll angle ±5°

### Definition of the Spatial Sampling Frequency

- The Spatial Sampling Frequency is the reciprocal of the 95th percentile of the distribution function of the maximum distances between neighboring scan points. When considering any individual scan point, the probability to find its most distant neighbor within the reciprocal of the Spatial Sampling Frequency is 95%.

### Assumptions for calculation of the Covered Area per Time

- 20% overlap of neighboring flight strips. This overlap covers a roll angle of ±5° or a reduction of flight altitude AGL of 20%.

## Technical Data RIEGL LMS-Q780 (continued)

### Data Interfaces

- Configuration
- Monitoring Data Output
- Digitized Data Output
- Synchronization

- TCP/IP Ethernet (10/100 MBit), RS232 (19.2 kBd)
- TCP/IP Ethernet (10/100 MBit)
- High speed serial data link to RIEGL Data Recorder
- Serial RS232 interface, TTL input for 1 pps synchronization pulse, accepts different data formats for GNSS-time information

### General Technical Data

- Power Supply / Current Consumption
- Main Dimensions (L x W x H) / Weight
- Protection Class
- Max. Flight Altitude operating / not operating
- Temperature Range
- Mounting of IMU-Sensor

- 18 - 32 V DC / approx. 7 A @ 24 VDC
- 480 x 212 x 279 mm / approx. 20 kg
- IP54
- 18500 ft (5600 m) above Mean Sea Level MSL / 18500 ft (5600 m) above MSL
- 5°C up to +40°C (operation) / -10°C up to +50°C (storage)
- Steel thread inserts on both sides of the laser scanner, rigidly connected to the inner structure of the scanning mechanism

# Dimensional Drawings RIEGL LMS-Q780

rear view

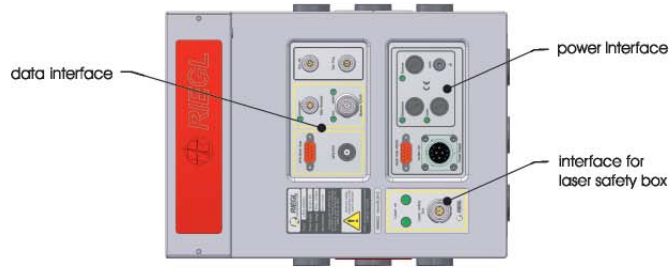

bottom view

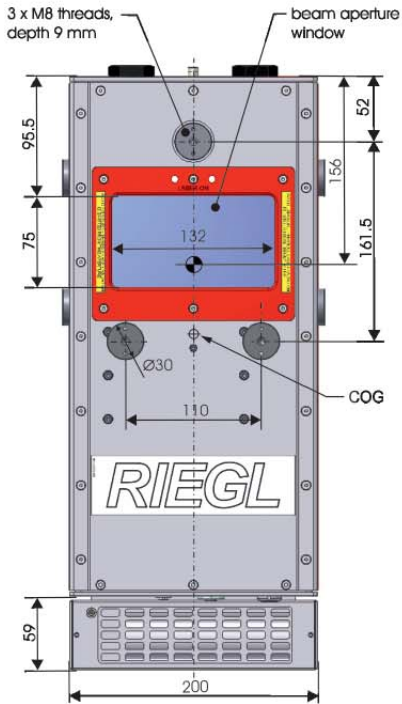

side view

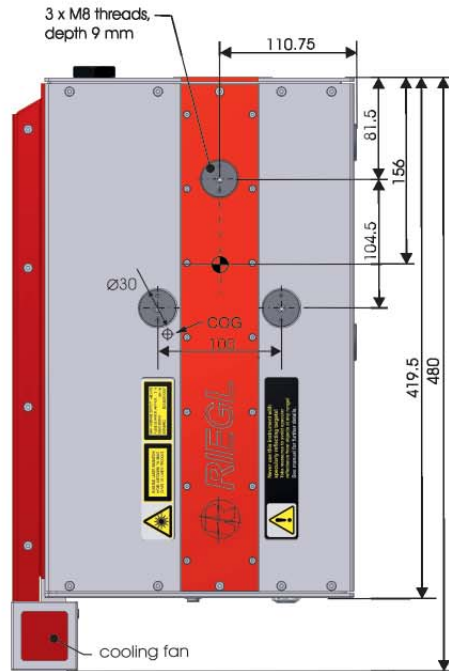

top view

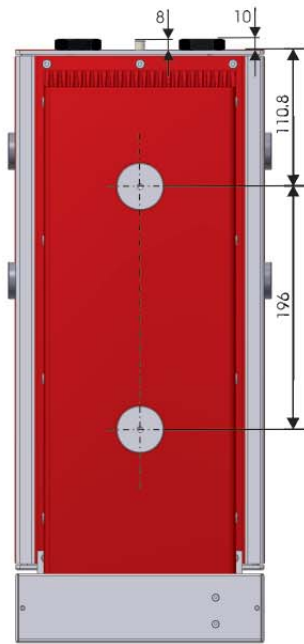

front view

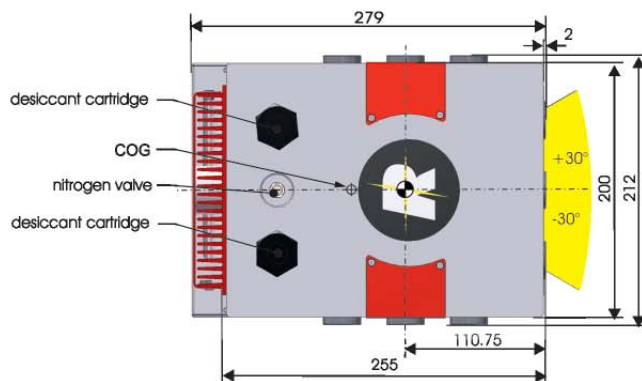

all dimensions in mm

● origin of scanner's local coordinate system

⊕ center of gravity COG

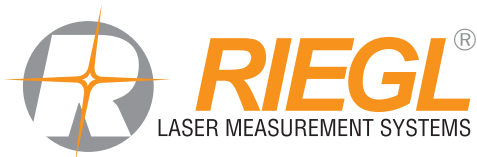

**RIEGL Laser Measurement Systems GmbH**  
Riedenburgstraße 48  
3580 Horn, Austria  
Phone: +43 2982 4211 | Fax: +43 2982 4210  
office@riegl.co.at  
www.riegl.com

**RIEGL USA Inc.**  
Orlando, Florida | info@rieglusa.com | www.rieglusa.com  
**RIEGL Japan Ltd.**  
Tokyo, Japan | info@riegl-japan.co.jp | www.riegl-japan.co.jp  
**RIEGL China Ltd.**  
Beijing, China | info@riegl.cn | www.riegl.cn

[www.riegl.com](http://www.riegl.com)